

10

by Rina Mardiati

Submission date: 26-Apr-2023 04:38PM (UTC+0700)

Submission ID: 2075988175

File name: 31_Fikri.pdf (569.98K)

Word count: 2868

Character count: 14299

Fuzzy Logic Control for Avoiding Static Obstacle in Autonomous Vehicle Robot

Fikri Ahmad Fauzi

Department of Electrical Engineering
 UIN Sunan Gunung Djati Bandung
 Bandung, Indonesia
 fauzifikri16@gmail.com

Rina Mardiaty

Department of Electrical Engineering
 UIN Sunan Gunung Djati Bandung
 Bandung, Indonesia
 r_mardiaty@uinsgd.ac.id

Edi Mulyana

Department of Electrical Engineering
 UIN Sunan Gunung Djati Bandung
 Bandung, Indonesia
 edim@uinsgd.ac.id

Aan Eko Setiawan

Department of Electrical Engineering
 UIN Sunan Gunung Djati Bandung
 Bandung, Indonesia
 aaneo37@gmail.com

Abstract—In the fields of technology and industrial automation, robots are now widely used to help reduce human labor. A robot is a mechanical system that can perform complex actions automatically based on computer programmed. In order to build an automated robot, navigation is one of the main problems that still to be solved until now. Many researchers have been use various methods to improve the navigation system of autonomous robots. This research attempts to implement a fuzzy method in an autonomous robot, which aims to maintain the distance between the robot and the obstacle, so that the robot can avoid the obstacle smoothly. In this study, we used three HCSR04 ultrasonic sensors as an input that installed on the front of the robot, and the Arduino MEGA 2560 as a microcontroller. The experiment has been done using case study where the distance of obstacle to the right sensor, middle sensor, and left sensor is 5 cm, 8 cm, and 17 cm respectively. The output of fuzzy is the speed of the PWM motor. Based on the results, the simulation shows the speed of right and left PWM motor is 167 and 33.4 respectively. Meanwhile, the experiment show that the right side PWM motor is 166.61 and the left side motor PWM is 33.89. According to this result, we can conclude that the fuzzy logic control was successfully implemented in the robot to avoid obstacles, the performance value of the right motor is 99.998%, and the performance value of the left motor is 99.086%. It can be seen that the output comparison between the simulation with the realization in the robot is not much different, it's indicate that the realization of fuzzy logic in the robot to avoid obstacles is successful.

Keywords—obstacle avoidance robot, fuzzy logic, ultrasonic sensor, motion control.

I. INTRODUCTION

In the fields of technology and industrial automation, robots are now widely used to help human work. A robot is a mechanical system that can perform a complex actions programmed automatically by a computer. The use of robots is one of the correct solutions to achieve what is considered monotonous. To carry out this task, many researchers developed a good navigation system using various methods so that the robot can function in the best way [1][2][3][4][5][6].

To build an automated robot, navigation is one of the main problems designers will face. Today, there are many control methods are available to be implemented in navigation system of robot. The fuzzy logic-based controller is a kind of control method belonging to artificial intelligence

[7][8][9][10]. The controller based on fuzzy logic combines mathematical calculations and algorithms to control the robot's behavior in the face of environmental dynamics.

In the previous several studies, the application of fuzzy logic in mobile robots has been widely used and developed, compared with PD and PID-based controllers, fuzzy-based controllers have low overshoot and small errors [11] [12] [13]. In research conducted by Osivue, a diffuse obstacle avoidance system was developed for older assistants and assistant walking robots (EWR) using ultrasonic sensors installed on the front of the robot. The robot uses a reaction strategy determined by sensory information to interact with the unfamiliar environment [10].

In this research, we implemented fuzzy logic control in an autonomous robot. One of the important factors for robots to successfully perform their functions is navigation. Different from previous research, this research attempts to implement a fuzzy method in the robot, which aims to maintain the distance between the robot and the obstacle, so that the robot can avoid the obstacle. In order to meet this ability, a sensor that can detect the distance and obstacles of the robot must be installed so that the controller can calculate and determine the appropriate control signal to send to the robot actuator.

Three HCSR04 ultrasonic sensors are used in the input part of the robot, which are installed on the front of the robot. The advantage of this kind of fuzzy logic is that the working range of the controller goes to the point where some ranges of data will be processed mathematically and combined with some algorithms (in that case, method) created in the control rules (rule base). Using this fuzzy logic principle, the robot's movement becomes more natural, because it will adjust according to the distance between the robot and the obstacle. In practice, the application of fuzzy logic principles in system design requires three stages: fuzzification, reasoning, and defuzzification. Fuzzification is the process of transforming real data into fuzzy sets, and reasoning is making decisions in a certain way. At the same time, defuzzification returns the fuzzy values to their true values. Arduino MEGA 2560 is used to execute all commands including data acquisition, fuzzification, inference, defuzzification, and movable sensors on the robot.

The paper is organized as follows. Section 1 gives a general introduction, while Section 2 described the design

9 and implementation. In Section 3 describes the results. Finally, Section 4 presents the conclusion and future works.

32 II. DESIGN AND IMPLEMENTATION

4 A. Block Diagram System

The design 4 of obstacle avoidance robots based on fuzzy logic control is divided into three system stages, namely input, process, and output as shown in Fig.1. In the input process, three HC-SR04 ultrasonic sensors are attached to the front of the robot, namely the right sensor, the middle sensor, and the left sensor.

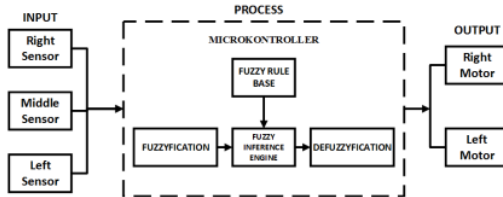

4 Fig. 1. The block diagram of this control system.

The way the obstacle avoidance robot works is based on fuzzy logic control which includes several parts, namely input, process, and output. Overall all of these parts are related to each other so that a robot that is ready to use can be created.

1. The input port is a distance sensor which obtained from three HC-SR04 ultrasonic sensors. This sensor function is to measure and provide information about the distance of the robot to the obstacle in front of it.
2. The process section is the main part of this system since this part works based on the input (distance). This section uses the Arduino MEGA 2560 microcontroller that embedded with fuzzy logic control to process the input.
3. This output section is the final result that obtained from fuzzy logic algorithm has been developed. The output of this system are the speed of PWM motor right and left.

B. Hardware Design

In the design of obstacle avoidance robots based on fuzzy logic control, several supporting electronic and non-electronic components are used. It can be seen the name and number of devices needed in the Tracking Obstacle Robot design in Table I.

20

TABLE I. HARDWARE COMPONENT

No	Component	Lots
1	Smart car chassis 2 WD Aluminium	1
2	Arduino MEGA 2560	1
3	Motor drivershield L293D	1
4	Motor DC	2
5	Battery Lippo 11 Volt	1
6	Ultrasonic Sensor HC-SR04	3
7	Cable	40

In Fig. 2 show the overall circuit scheme that used in the design of the obstacle avoidance-based robot.

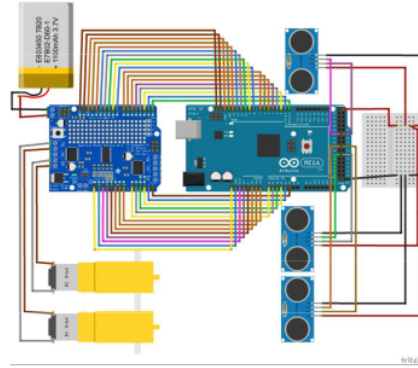

Fig. 2. Circuit System.

C. Fuzzy Model for Navigation the Autonomous Robot

In this chapter, there are three main steps to developed fuzzy model for navigate the robot to avoid the static obstacles, which are fuzzyfication, implementation of fuzzy rule based and defuzzyfication. The input variable of this fuzzy model are distance between obstacle and robot that obtained from sensors. Table II shown the linguistic term of input, we divide the input into three linguistic term, namely near, moderate, and far for each sensor (right, middle, and left). Meanwhile, Table III shown the linguistic term of output. We divide the output become three different speed, which are slow, normal, and fast for each motor (right and left).

TABLE II. LINGUISTIC TERM OF INPUT

Distance (centimeter)	Linguistic Term		
	right	middle	left
[0 0 5 10]	Near (de)	Near (DE)	Near (De)
[5 10 15 20]	Moderate (te)	Moderate (TE)	Moderate (Te)
[15 20 25 25]	Far (ja)	Far (JA)	Far (Ja)

TABLE III. LINGUISTIC TERM OF OUTPUT

Motor Speed (PWM)	Linguistic Term	
	Left wheel	Right wheel
[0 0 50 75]	Slow (la)	Slow (LA)
[50 75 125 150]	Normal (no)	Normal (NO)
[125 150 200 200]	Fast (ce)	Fast (CE)

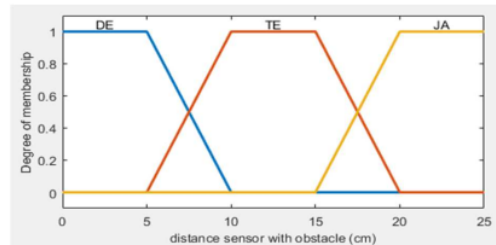

Fig. 3. Membership function of right sensor.

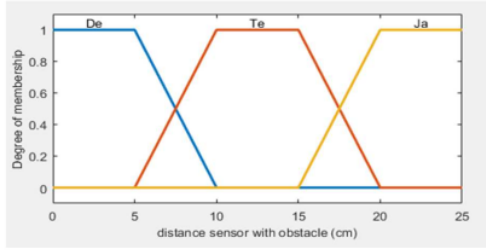

Fig. 4. Membership function of left sensor.

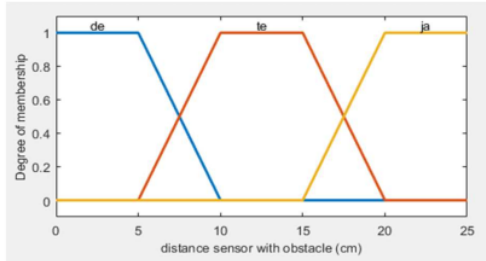

Fig. 5. Membership Function of middle sensor.

Fig. 3., 4., and 5. shows the membership function of input (right, middle, and left sensor). The mathematical equations of each membership function are shown in Table IV.

TABLE IV. EQUATION TERM OF MF INPUT.

μ of 3 sensor	
$\mu_{de} = \begin{cases} 1, & x \leq 5 \\ \frac{10-x}{5}, & 5 \leq x \leq 10 \\ 0, & x \geq 10 \end{cases} \quad (1)$	
$\mu_{te} = \begin{cases} \frac{x-5}{5}, & 5 \leq x \leq 10 \\ 1, & 10 \leq x \leq 15 \\ \frac{20-x}{5}, & 15 \leq x \leq 20 \end{cases} \quad (2)$	
$\mu_{ja} = \begin{cases} \frac{x-15}{5}, & 15 \leq x \leq 20 \\ 1, & x \geq 25 \end{cases} \quad (3)$	

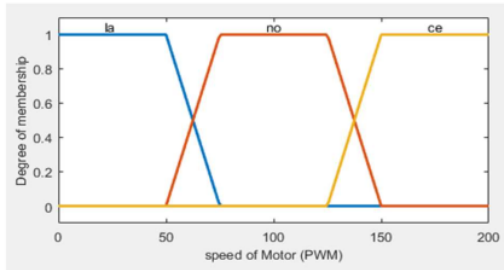

Fig. 6. MF output of left motor speed.

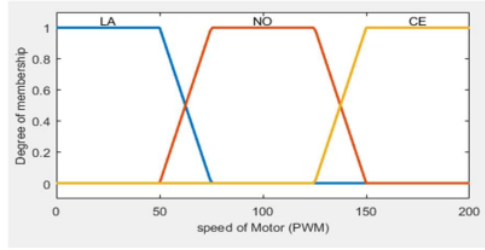

Fig. 7. MF output of right motor speed.

The membership function of output has shown in Fig. 6 and 7., using trapezoidal shape [36]. The mathematical equations of this membership function can be seen in Table V.

TABLE V. EQUATION TERM OF MF OUTPUT.

μ of motor speed	
$\mu_{la} = \begin{cases} 1, & x \leq 50 \\ \frac{75-x}{25}, & 50 \leq x \leq 75 \\ 0, & x \geq 75 \end{cases} \quad (4)$	
$\mu_{no} = \begin{cases} \frac{x-50}{45}, & 50 \leq x \leq 75 \\ 1, & 75 \leq x \leq 125 \\ \frac{150-x}{25}, & 125 \leq x \leq 150 \end{cases} \quad (5)$	
$\mu_{ce} = \begin{cases} \frac{x-125}{25}, & 135 \leq x \leq 150 \\ 1, & x \leq 200 \end{cases} \quad (6)$	

After we define the linguistic input and output with the membership function graphs, the next step is to define the fuzzy rule for this system in order to make the robot can smoothly avoid the static obstacles as shown in Table VI.

TABLE VI. FUZZY RULES

Rules	Input (sensors)			Output (motor)	
	right	middle	left	right	left
R1	Near	Near	Near	Fast	Slow
R2	Near	Near	moderate	Fast	Slow
R3	Near	Near	Far	Fast	Slow
R4	Near	moderate	Near	Fast	Normal
R5	Near	moderate	moderate	Fast	Slow
R6	Near	moderate	Far	Fast	Slow
R7	Near	Far	Near	Fast	Slow
R8	Near	Far	moderate	Fast	Slow
R9	Near	Far	Far	Fast	Slow
R10	moderate	Near	Near	Slow	Fast
R11	moderate	Near	moderate	Slow	Fast
R12	moderate	Near	Far	Fast	Slow
R13	moderate	moderate	Near	Slow	Fast
R14	moderate	moderate	moderate	Slow	Fast
R15	moderate	moderate	Far	Fast	Slow
R16	moderate	Far	Near	Fast	Fast
R17	moderate	Far	moderate	Fast	Fast

R18	moderate	Far	Far	Fast	Normal
R19	8	Near	Near	Slow	Fast
R20	Far	Near	middle	Slow	Fast
R21	Far	Near	Far	Slow	Fast
R22	Far	moderate	Near	Slow	Fast
R23	Far	moderate	moderate	Slow	Fast
R24	8	moderate	Far	Slow	Fast
R25	Far	Far	Near	Slow	Fast
R26	Far	Far	moderate	Slow	Fast
R27	Far	Far	Far	Normal	Normal

D. Implementation

After implementing and installing all the components of the robot, it can be seen in Figure 8 the realization of our design. Fig. 8(a) is the front view of the robot that consist of three ultrasonic sensors HC-SR04 which are mounted with the right tilted sensor position, the center sensor is straight forward and the left sensor is tilted to the left. In Fig. 8 (b) shows the view from top of our robot circuit. We can see from the top of the robot, there are motor driver shield series L293D installed on the Arduino MEGA 2560 and connected to all the components installed on the robot.

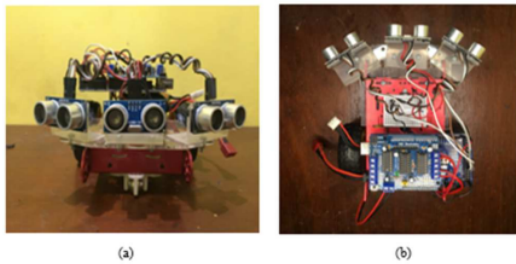

Fig. 8. Robot (a) front view; (b) top view.

III. RESULT AND ANALYSIS

In this study, we did an experiment to find out how well our proposed fuzzy model that implemented to autonomous robot to avoid the static obstacle. We used case study using an environment that placed a static obstacle in certain position, which is the distance from the sensor are 5 cm, 8 cm, 17 cm, for right, middle, 24 left sensor respectively. The environment scenario can be seen in Fig. 9.



Fig. 9. The environment of experiment.

The result from the experiment is compared with the simulation result. As shown in Fig. 11, the experiment shows the PWM output on the right motor is 166,61 and the PWM output on the left motor is 33,89. Meanwhile, Fig. 11 shows the result from simulation, which are speed of right PWM is 167, and left PWM is 33.4.

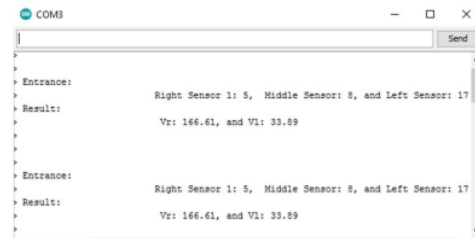

Fig. 10. Result of fuzzy design in simulation.

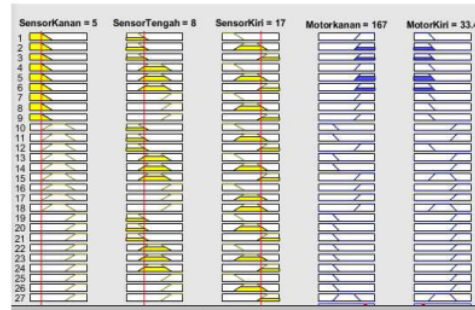

Fig. 11. Results of the implementation in Arduino IDE.

Based on this result, generally we can conclude that fuzzy logic has been well implemented in our robot. With the error value can be calculated with Equation 7, as follows.

$$error = \left| \frac{x - \bar{x}}{\bar{x}} \right| \times 100\% \quad (7)$$

Where x is result from experiment, while \bar{x} is the result from simulation.

error value right motor

$$error = \frac{166,61-167}{167} \times 100\% = 0,002\%$$

error value left motor

$$error = \frac{33,89-33,4}{33,4} \times 100\% = 0,014\%$$

With the results of the error value, the fuzzy logic control method was successfully implemented on the obstacle avoidance robot with a yield value of 99.998% on the right motor and 99.086% on the left motor.

IV. CONCLUSION

In this study, research on obstacle avoidance robots was carried out. From the study case with an input of system are 5cm, 8cm, and 17cm that represent the distance of right, middle, and left sensor respectively, the simulation shows the speed of right and left PWM motor is 167 and 33.4 respectively. Meanwhile, the experiment show that the right side PWM motor is 166.61 and the left side motor PWM is 33.89. According to this result, we can conclude that the fuzzy

logic control was successfully implemented in the robot to avoid obstacles, the performance value of the right motor is 99.998%, and the performance value of the left motor is 99.086%. It can be seen that the output comparison between the simulation with the realization in the robot is not much different, it's indicate that the realization of fuzzy logic in the robot to avoid obstacles is successful.

REFERENCES

- [1] H. Husnawati, "Penerapan Metode Fuzzy Sugeno Sebagai Sistem Navigasi Robot Menggunakan Mikrokontroler Arduino dan Sensor Ultrasonik," *J. Ilm. Inform. Glob.*, vol. 9, no. 1, pp. 40–48, 2018, doi: 10.6982/jig.v9i1.483.
- [2] G. Dewantoro, D. Susilo, and P. P. Adi, "Implementasi Pengendali Logika Fuzzy pada Navigasi Robot Penjejak Dinding," *Maj. Ilm. Teknol. Elektro*, vol. 16, no. 2, p. 72, 2017, doi: 10.24843/mite.2017.v16i02p13.
- [3] M. Y. Hidayat, W. Kumiawan, and R. Maulana, "Implementasi Algoritma Wall Following pada Manuver Robot KRPA adruped Omni Direction Menggunakan Metode Fuzzy Sugeno," *J. Pengemb. Teknol. Inf. dan Ilmu Komput. Univ. Brawijaya*, vol. 2, no. 11, pp. 57–4965, 2018.
- [4] R. Mardiaty, B. R. Trilaksono, Y. S. Gondokaryono, and S. S. Sulaksono, "Motorcycle's trajectory tracking model based on polynomial least-squares approximation," *Adv. Sci. Lett.*, vol. 23, no. 5, pp. 4537–4541, 2017, doi: 10.1166/asl.2017.8974.
- [5] R. Mardiaty, B. R. Trilaksono, Y. S. Gondokaryono, and S. S. Wibowo, "Motorcycle movement model based on markov chain process in mixed traffic," *Int. J. Electr. Comput. Eng.*, vol. 8, no. 5, pp. 3149–3157, 2018, doi: 10.11591/ijece.v8i5.pp3149-3157.
- [6] R. Mardiaty, B. R. Trilaksono, S. S. Wibowo, and D. S. Laila, "Modeling Motorcycle Maneuvering in Urban Scenarios Using Markov Decision Process with Dynamical-Discretized Reward Field," *Int. J. Automot. Technol.*, vol. 22, no. 4, pp. 967–977, 2021, doi: 10.1007/s12239-021-0087-2.
- [7] A. Mutolib, A. E. Setiawan, R. Mardiaty, and E. Mulyana, "Design of automatic Goods Carrier Robot System Based on Line Sensor And Fuzzy Logic Control Mamdani," *Proc. - 2020 6th Int. Conf. Wirel. Telemat. ICWT 2020*, pp. 1–4, 2020, doi: 10.1109/ICWT50448.2020.9243615.
- [8] M. Adhipramana, R. Mardiaty, and E. Mulyana, "Remotely operated vehicle (ROV) robot for monitoring quality of water based on IoT," *Proc. - 2020 6th Int. Conf. Wirel. Telemat. ICWT 2020*, 2020, doi: 10.1109/ICWT50448.2020.9243614.
- [9] I. N. Lestari, E. Mulyana, and R. Mardiaty, "The implementation of mamdani's fuzzy model for controlling the temperature of chicken egg incubator," *Proc. - 2020 6th Int. Conf. Wirel. Telemat. ICWT 2020*, 2020, doi: 10.1109/ICWT50448.2020.9243647.
- [10] O. R. Osivue, X. Zhang, X. Mu, H. Han, and Y. Wang, "Approach for Obstacle Avoidance Fuzzy Logic Control of an Elderly Assistant and Walking-assistant Robot Using Ultrasonic Sensors Approach for Obstacle Avoidance Fuzzy Logic Control of An Elderly-assistant and Walking-assistant Robot Using Ultrasonic Senso," *2018 15th Int. Conf. Ubiquitous Robot.*, no. June, pp. 708–713, 2018, doi: 10.1109/URAI.2018.8441818.
- [11] F. FAHMIZAL, B. B. MURTI, D. B. PRATAMA, and A. MAYUB, "Kendali Logika Fuzzy pada Car Like Mobile Robot (CLMR) Penjejak Garis," *ELKOMIKA J. Tek. Energi Elektr. Tek. Telekomun. Tek. Elektron.*, vol. 6, no. 3, p. 451, 2018, doi: 10.26760/elkomika.v6i3.451.
- [12] T. A. Smith, "Simulasi sistem kendali kestabilan motor DC menggunakan PID dan fuzzy logic control," Universitas Negeri Semarang, 2016.
- [13] A. Najmurokhan and B. H. S. R. Wibowo, "Desain Pengendali Logika Fuzzy Tipe Takagi-Sugeno-Kang Untuk Mengatur Kecepatan Gerak Mobile Robot," in *Seminar Nasional Sains dan Teknologi*, 2018, pp. 1–8.

ORIGINALITY REPORT

32%
SIMILARITY INDEX

20%
INTERNET SOURCES

22%
PUBLICATIONS

12%
STUDENT PAPERS

PRIMARY SOURCES

1 jitce.fti.unand.ac.id **3%**
Internet Source

2 jurnal.untan.ac.id **2%**
Internet Source

3 Rachma Dianty, Rina Mardiaty, Edi Mulyana, Dedi Supriadi. "Design of Humidity Control with Automatic Drip Irrigation System Based on Fuzzy Logic Using Node-RED and MQTT on Cactus Plants", 2021 7th International Conference on Wireless and Telematics (ICWT), 2021 **2%**
Publication

4 Sindy Faj Misa Putri, Rina Mardiaty, Aan Eko Setiawan. "The Prototype of Arm Robot for Object Mover Using Arduino Mega 2560", 2022 8th International Conference on Wireless and Telematics (ICWT), 2022 **2%**
Publication

5 Rina Mardiaty, Bambang R Trilaksono, Yudi S Gondokaryono, Sony S Wibowo. "Motorcycle Movement Model Based on Markov Chain **2%**

Process in Mixed Traffic", International Journal of Electrical and Computer Engineering (IJECE), 2018

Publication

6

digilib.uinsgd.ac.id

Internet Source

2%

7

Rafsanjani, I P D Wibawa, C Ekaputri. "Speed and steering control system for self-driving car prototype", Journal of Physics: Conference Series, 2019

Publication

1%

8

Ying Xiong, Shide Xiao, Feng Zha. "An avoiding obstacle algorithm of mobile robot under complex unknown environments", 2011 Second International Conference on Mechanic Automation and Control Engineering, 2011

Publication

1%

9

Asep Khoerudin, Edi Mulyana, Rina Mardiaty, Aan Eko Setiawan. "Design and Simulation Transfer Learning on Image Processing for Determining Condition of Robot Based on Neural Network", 2021 7th International Conference on Wireless and Telematics (ICWT), 2021

Publication

1%

10

www.jurnal.stkipppgritulungagung.ac.id

Internet Source

1%

11	ksae.org Internet Source	1 %
12	Pritam Paral, Amitava Chatterjee, Anjan Rakshit. "Human Position Estimation Based on Filtered Sonar Scan Matching: A Novel Localization Approach using DENCLUE", IEEE Sensors Journal, 2021 Publication	1 %
13	ir.jkuat.ac.ke Internet Source	1 %
14	Y. Wang, J. Yang, S. Wang, D. Bai. "Walking Assist Robot: A Novel Approach to Parameter Optimization of a Tracking Controller Compensating for Time Varying Friction", IEEE Access, 2018 Publication	1 %
15	icwt-seei.org Internet Source	1 %
16	journal.unnes.ac.id Internet Source	1 %
17	123dok.com Internet Source	1 %
18	Farhan Fauzi, Adam Faroqi, Lia Kamelia, Aan Eko Setiawan. "E-KTP based Alternative Ignition System on Motorcycles using an ATmega328 Microcontroller", 2022 8th	1 %

International Conference on Wireless and Telematics (ICWT), 2022

Publication

19

Saif AlShamsi, Laila AlSuwaidi, Khaled Shaalan. "Chapter 18 Robotics and AI in Healthcare: A Systematic Review", Springer Science and Business Media LLC, 2022

Publication

1 %

20

Submitted to School of Business and Management ITB

Student Paper

1 %

21

Submitted to International Islamic University Malaysia

Student Paper

1 %

22

Submitted to University of Hertfordshire

Student Paper

1 %

23

www.ejurnal.stmik-budidarma.ac.id

Internet Source

1 %

24

J.-W. Kang, S.-K. Sul. "Analysis and prediction of inverter switching frequency in direct torque control of induction machine based on hysteresis bands and machine parameters", IEEE Transactions on Industrial Electronics, 2001

Publication

1 %

25

publikasi.dinus.ac.id

Internet Source

1 %

26	publikasi.mercubuana.ac.id Internet Source	1 %
27	repository.ub.ac.id Internet Source	1 %
28	"Table of Content", 2021 7th International Conference on Wireless and Telematics (ICWT), 2021 Publication	<1 %
29	Min-Fan Ricky Lee, Nguyen The Hung, Fu-Hsin Steven Chiu. "An autonomous mobile robot for indoor security patrol", 2013 International Conference on Fuzzy Theory and Its Applications (iFUZZY), 2013 Publication	<1 %
30	ejournal.uigm.ac.id Internet Source	<1 %
31	mafiadoc.com Internet Source	<1 %
32	Dzulfikri Hanafi, Rina Mardiaty, Toni Prabowo, Cecep Hidayat. "Growth Monitoring System and Automatic Watering for Chili Plants Based on Internet of Things", 2021 7th International Conference on Wireless and Telematics (ICWT), 2021 Publication	<1 %
33	www.slideshare.net Internet Source	<1 %

34

core.ac.uk

Internet Source

<1 %

35

Muhammad Daffa Fadillah, Nanang Ismail, Rina Mardiaty, Ading Kusdiana. "Fuzzy Logic-Based Control System to Maintain pH in Aquaponic", 2021 7th International Conference on Wireless and Telematics (ICWT), 2021

Publication

<1 %

36

Muhammad Yasir, Indri Nurfaizri Lestari, Cucu Setiawan, Ulfiah, Mufid Ridlo Effendi, Eki Ahmad Zaki Hamidi. "Design and Implementation of The Blind Navigation Aids Using Ultrasonic Sensor", 2021 7th International Conference on Wireless and Telematics (ICWT), 2021

Publication

<1 %

37

Jakup Berisha, Xhevahir Bajrami, Ahmet Shala, Rame Likaj. "Application of Fuzzy Logic Controller for obstacle detection and avoidance on real autonomous mobile robot", 2016 5th Mediterranean Conference on Embedded Computing (MECO), 2016

Publication

<1 %

Exclude bibliography Off